

## Power MOSFET

PRODUCT SUMMARY		
$V_{DS}$ (V)	400	
$R_{DS(on)}$ ( $\Omega$ )	$V_{GS} = 10$ V	0.20
$Q_g$ (Max.) (nC)	110	
$Q_{gs}$ (nC)	28	
$Q_{gd}$ (nC)	45	
Configuration	Single	

### FEATURES

- Ultra Low Gate Charge
- Reduced Gate Drive Requirement
- Enhanced 30 V  $V_{GS}$  Rating
- Reduced  $C_{iss}$ ,  $C_{oss}$ ,  $C_{rss}$
- Isolated Central Mounting Hole
- Dynamic  $dV/dt$  Rated
- Repetitive Avalanche Rated
- Lead (Pb)-free Available

 Available  
**RoHS\***  
 COMPLIANT

### DESCRIPTION

This new series of low charge Power MOSFETs achieve significantly lower gate charge over conventional MOSFETs. Utilizing advanced MOSFETs technology the device improvements allow for reduced gate drive requirements, faster switching speeds and increased total system savings. These device improvements combined with the proven ruggedness and reliability of MOSFETs offer the designer a new standard in power transistors for switching applications. The TO-247 package is preferred for commercial-industrial applications where higher power levels preclude the use of TO-220 devices. The TO-247 is similar but superior to the earlier TO-218 package because of its isolated mounting hole.

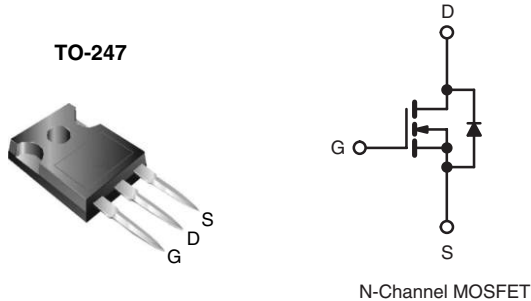

ORDERING INFORMATION	
Package	TO-247
Lead (Pb)-free	IRFP360LCPbF
	SiHFP360LC-E3
SnPb	IRFP360LC
	SiHFP360LC

ABSOLUTE MAXIMUM RATINGS $T_C = 25$ °C, unless otherwise noted				
PARAMETER	SYMBOL	LIMIT	UNIT	
Drain-Source Voltage	$V_{DS}$	400	V	
Gate-Source Voltage	$V_{GS}$	$\pm 30$		
Continuous Drain Current	$V_{GS}$ at 10 V	$T_C = 25$ °C	23	
		$T_C = 100$ °C		14
Pulsed Drain Current <sup>a</sup>	$I_{DM}$	91	A	
Linear Derating Factor		2.2	W/°C	
Single Pulse Avalanche Energy <sup>b</sup>	$E_{AS}$	1200	mJ	
Repetitive Avalanche Current <sup>a</sup>	$I_{AR}$	23	A	
Repetitive Avalanche Energy <sup>a</sup>	$E_{AR}$	28	mJ	
Maximum Power Dissipation	$T_C = 25$ °C	$P_D$	280	W
Peak Diode Recovery $dV/dt^c$	$dV/dt$	4.0	V/ns	
Operating Junction and Storage Temperature Range	$T_J, T_{stg}$	- 55 to + 150	°C	
Soldering Recommendations (Peak Temperature)	for 10 s	300 <sup>d</sup>		
Mounting Torque	6-32 or M3 screw	10	lbf · in	
		1.1	N · m	

#### Notes

- Repetitive rating; pulse width limited by maximum junction temperature (see fig. 11).
- $V_{DD} = 25$  V, starting  $T_J = 25$  °C,  $L = 4.0$  mH,  $R_G = 25$   $\Omega$ ,  $I_{AS} = 23$  A (see fig. 12).
- $I_{SD} \leq 23$  A,  $dI/dt \leq 170$  A/ $\mu$ s,  $V_{DD} \leq V_{DS}$ ,  $T_J \leq 150$  °C.
- 1.6 mm from case.

\* Pb containing terminations are not RoHS compliant, exemptions may apply

THERMAL RESISTANCE RATINGS				
PARAMETER	SYMBOL	TYP.	MAX.	UNIT
Maximum Junction-to-Ambient	$R_{thJA}$	-	40	°C/W
Case-to-Sink, Flat, Greased Surface	$R_{thCS}$	0.24	-	
Maximum Junction-to-Case (Drain)	$R_{thJC}$	-	0.45	

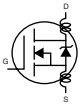
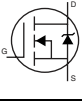
SPECIFICATIONS $T_J = 25\text{ }^\circ\text{C}$ , unless otherwise noted						
PARAMETER	SYMBOL	TEST CONDITIONS	MIN.	TYP.	MAX.	UNIT
<b>Static</b>						
Drain-Source Breakdown Voltage	$V_{DS}$	$V_{GS} = 0\text{ V}$ , $I_D = 250\text{ }\mu\text{A}$	400	-	-	V
$V_{DS}$ Temperature Coefficient	$\Delta V_{DS}/T_J$	Reference to $25\text{ }^\circ\text{C}$ , $I_D = 1\text{ mA}$	-	0.49	-	V/°C
Gate-Source Threshold Voltage	$V_{GS(th)}$	$V_{DS} = V_{GS}$ , $I_D = 250\text{ }\mu\text{A}$	2.0	-	4.0	V
Gate-Source Leakage	$I_{GSS}$	$V_{GS} = \pm 20\text{ V}$	-	-	$\pm 100$	nA
Zero Gate Voltage Drain Current	$I_{DSS}$	$V_{DS} = 400\text{ V}$ , $V_{GS} = 0\text{ V}$	-	-	25	$\mu\text{A}$
		$V_{DS} = 320\text{ V}$ , $V_{GS} = 0\text{ V}$ , $T_J = 125\text{ }^\circ\text{C}$	-	-	250	
Drain-Source On-State Resistance	$R_{DS(on)}$	$V_{GS} = 10\text{ V}$ $I_D = 14\text{ A}^b$	-	-	0.20	$\Omega$
Forward Transconductance	$g_{fs}$	$V_{DS} = 50\text{ V}$ , $I_D = 14\text{ A}^b$	13	-	-	S
<b>Dynamic</b>						
Input Capacitance	$C_{iss}$	$V_{GS} = 0\text{ V}$ , $V_{DS} = 25\text{ V}$ , $f = 1.0\text{ MHz}$ , see fig. 5	-	3400	-	pF
Output Capacitance	$C_{oss}$		-	540	-	
Reverse Transfer Capacitance	$C_{rss}$		-	42	-	
Total Gate Charge	$Q_g$	$V_{GS} = 10\text{ V}$ $I_D = 23\text{ A}$ , $V_{DS} = 320\text{ V}$ , see fig. 6 and 13 <sup>b</sup>	-	-	110	nC
Gate-Source Charge	$Q_{gs}$		-	-	28	
Gate-Drain Charge	$Q_{gd}$		-	-	45	
Turn-On Delay Time	$t_{d(on)}$	$V_{DD} = 200\text{ V}$ , $I_D = 23\text{ A}$ , $R_G = 4.3\text{ }\Omega$ , $R_D = 7.9\text{ }\Omega$ , see fig. 10 <sup>b</sup>	-	16	-	ns
Rise Time	$t_r$		-	75	-	
Turn-Off Delay Time	$t_{d(off)}$		-	42	-	
Fall Time	$t_f$		-	50	-	
Internal Drain Inductance	$L_D$	Between lead, 6 mm (0.25") from package and center of die contact	-	5.0	-	nH
Internal Source Inductance	$L_S$		-	13	-	
<b>Drain-Source Body Diode Characteristics</b>						
Continuous Source-Drain Diode Current	$I_S$	MOSFET symbol showing the integral reverse p - n junction diode	-	-	23	A
Pulsed Diode Forward Current <sup>a</sup>	$I_{SM}$		-	-	92	
Body Diode Voltage	$V_{SD}$	$T_J = 25\text{ }^\circ\text{C}$ , $I_S = 23\text{ A}$ , $V_{GS} = 0\text{ V}^b$	-	-	1.8	V
Body Diode Reverse Recovery Time	$t_{rr}$	$T_J = 25\text{ }^\circ\text{C}$ , $I_F = 23\text{ A}$ , $di/dt = 100\text{ A}/\mu\text{s}^b$	-	400	600	ns
Body Diode Reverse Recovery Charge	$Q_{rr}$		-	5.7	8.6	$\mu\text{C}$
Forward Turn-On Time	$t_{on}$	Intrinsic turn-on time is negligible (turn-on is dominated by $L_S$ and $L_D$ )				

**Notes**

- a. Repetitive rating; pulse width limited by maximum junction temperature (see fig. 11).
- b. Pulse width  $\leq 300\text{ }\mu\text{s}$ ; duty cycle  $\leq 2\%$ .

**TYPICAL CHARACTERISTICS** 25 °C, unless otherwise noted

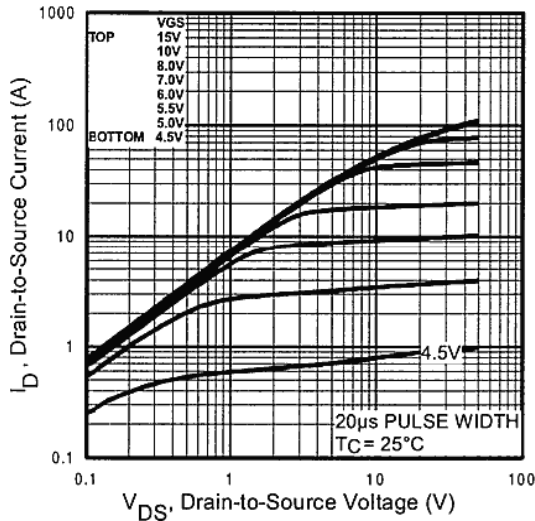

Fig. 1 - Typical Output Characteristics,  $T_c = 25^\circ\text{C}$

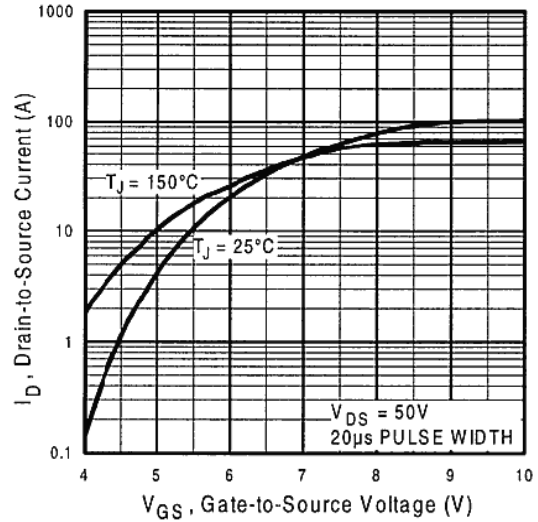

Fig. 3 - Typical Transfer Characteristics

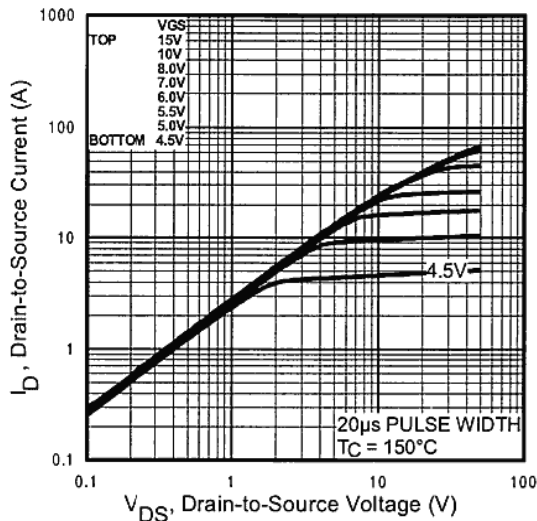

Fig. 2 - Typical Output Characteristics,  $T_c = 150^\circ\text{C}$

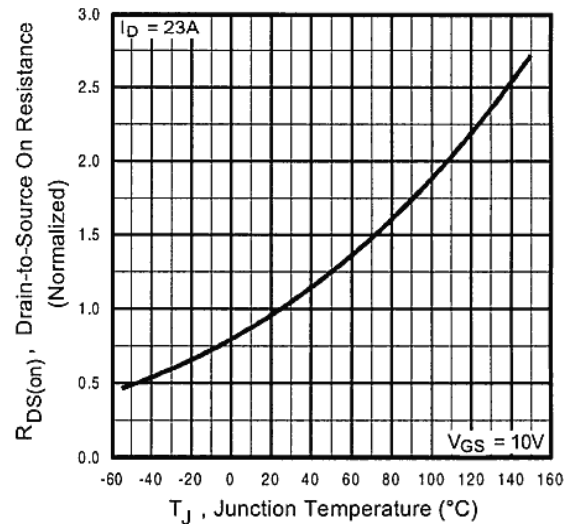

Fig. 4 - Normalized On-Resistance vs. Temperature

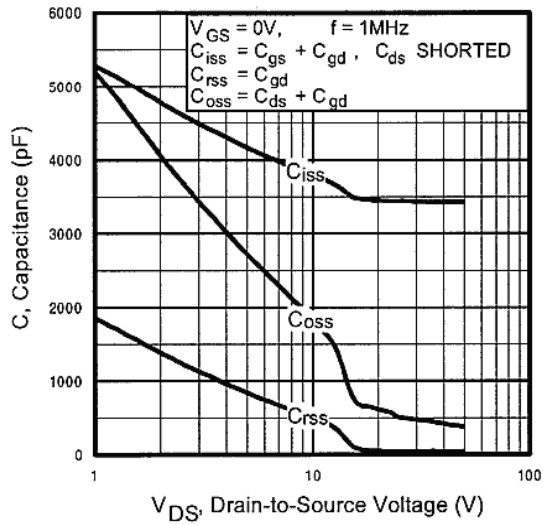

Fig. 5 - Typical Capacitance vs. Drain-to-Source Voltage

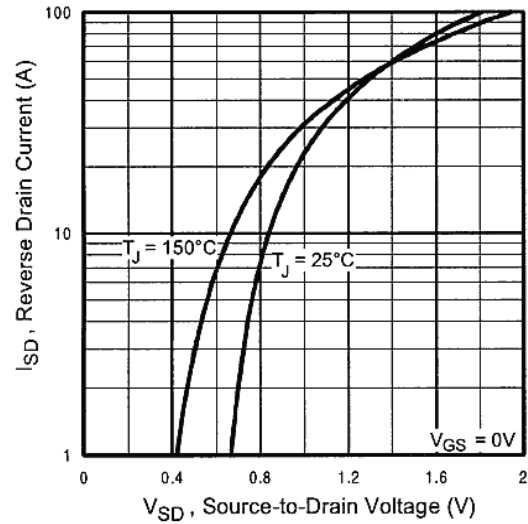

Fig. 7 - Typical Source-Drain Diode Forward Voltage

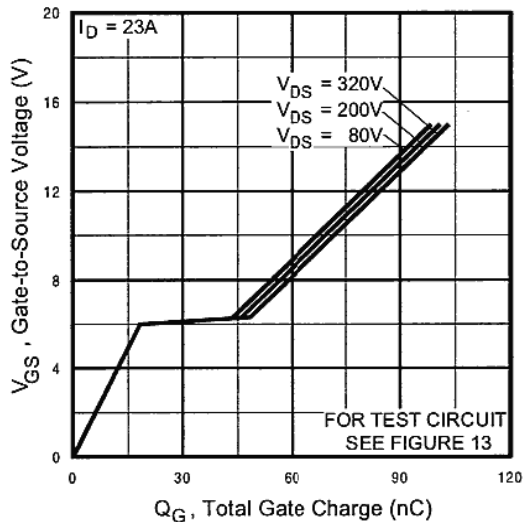

Fig. 6 - Typical Gate Charge vs. Gate-to-Source Voltage

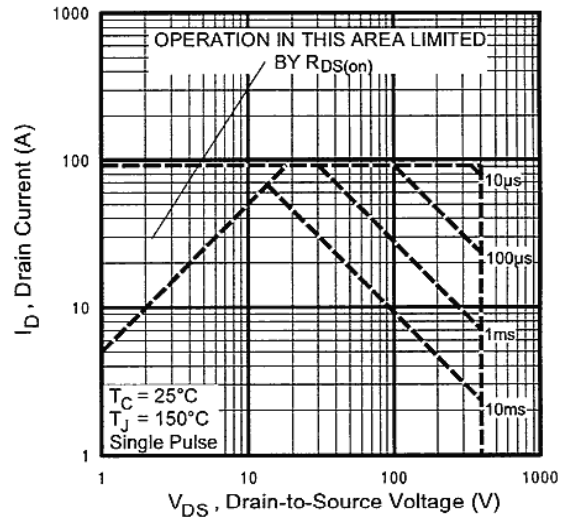

Fig. 8 - Maximum Safe Operating Area

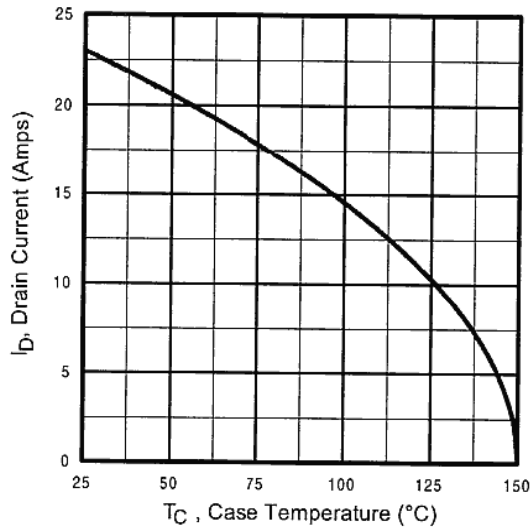

Fig. 9 - Maximum Drain Current vs. Case Temperature

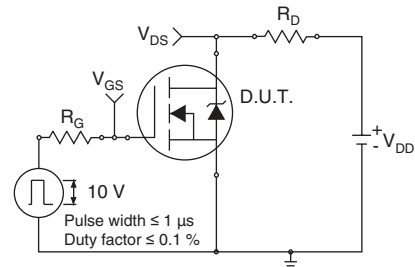

Fig. 10a - Switching Time Test Circuit

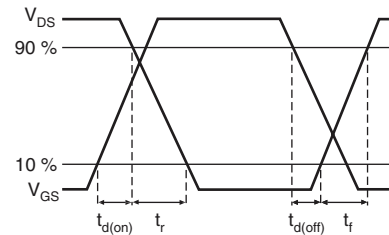

Fig. 10b - Switching Time Waveforms

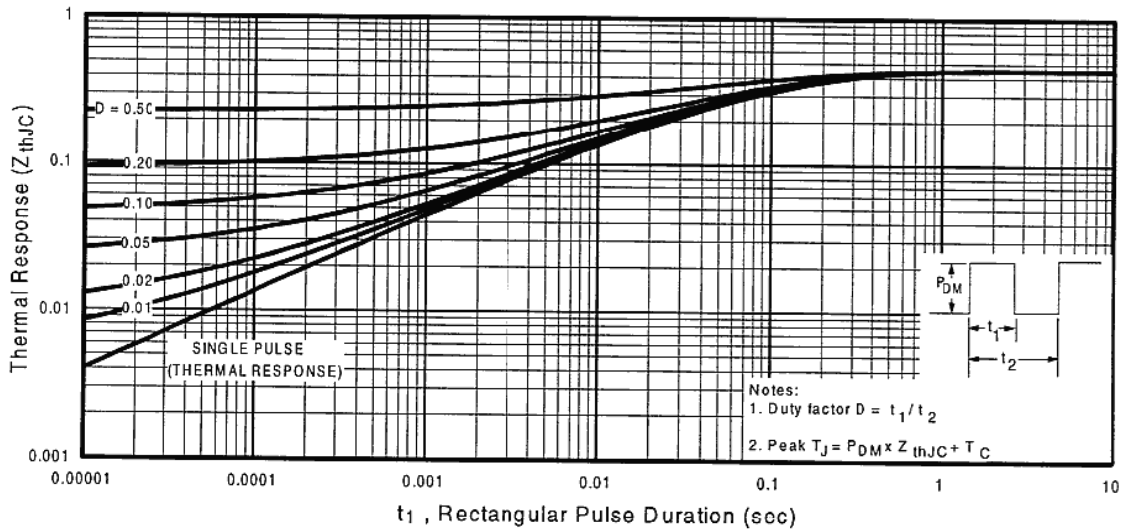

Fig. 11 - Maximum Effective Transient Thermal Impedance, Junction-to-Case

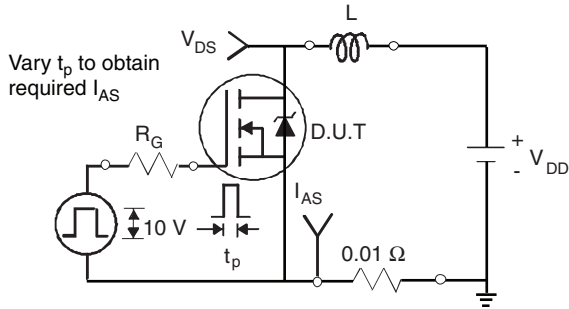

Fig. 12a - Unclamped Inductive Test Circuit

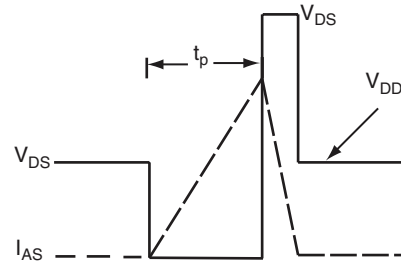

Fig. 12b - Unclamped Inductive Waveforms

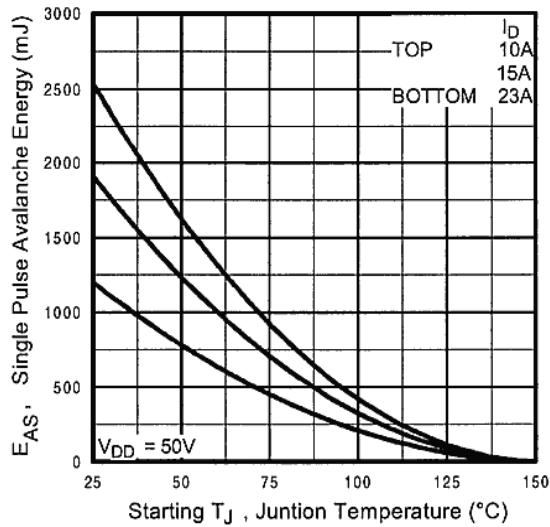

Fig. 12c - Maximum Avalanche Energy vs. Drain Current

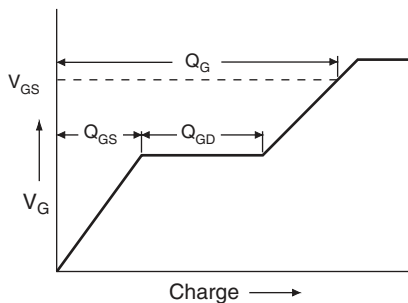

Fig. 13a - Basic Gate Charge Waveform

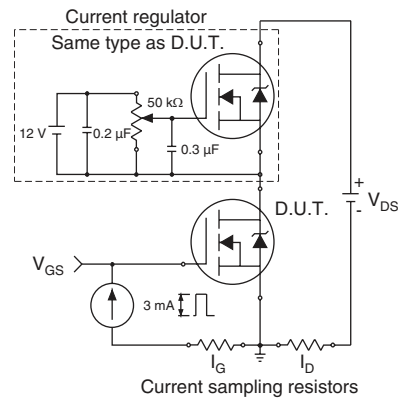

Fig. 13b - Gate Charge Test Circuit

## Peak Diode Recovery $dV/dt$ Test Circuit

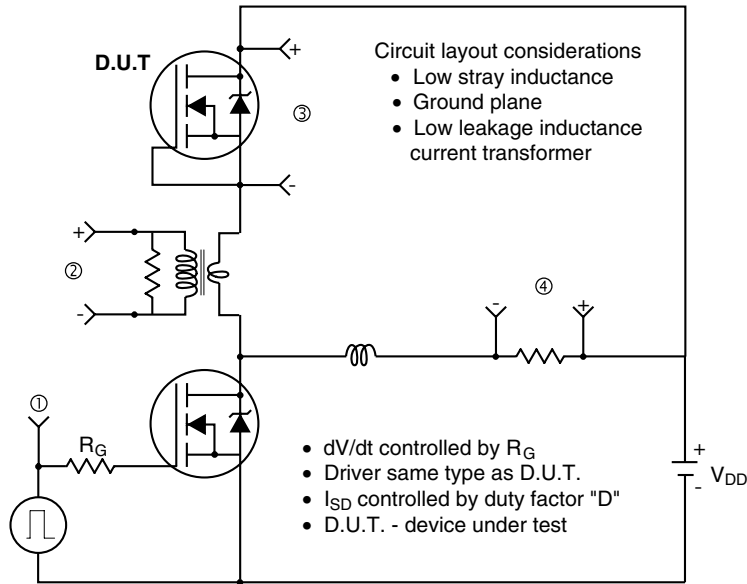

Fig. 14 - For N-Channel

Vishay Siliconix maintains worldwide manufacturing capability. Products may be manufactured at one of several qualified locations. Reliability data for Silicon Technology and Package Reliability represent a composite of all qualified locations. For related documents such as package/tape drawings, part marking, and reliability data, see <http://www.vishay.com/ppg?91227>.



## Disclaimer

All product specifications and data are subject to change without notice.

Vishay Intertechnology, Inc., its affiliates, agents, and employees, and all persons acting on its or their behalf (collectively, "Vishay"), disclaim any and all liability for any errors, inaccuracies or incompleteness contained herein or in any other disclosure relating to any product.

Vishay disclaims any and all liability arising out of the use or application of any product described herein or of any information provided herein to the maximum extent permitted by law. The product specifications do not expand or otherwise modify Vishay's terms and conditions of purchase, including but not limited to the warranty expressed therein, which apply to these products.

No license, express or implied, by estoppel or otherwise, to any intellectual property rights is granted by this document or by any conduct of Vishay.

The products shown herein are not designed for use in medical, life-saving, or life-sustaining applications unless otherwise expressly indicated. Customers using or selling Vishay products not expressly indicated for use in such applications do so entirely at their own risk and agree to fully indemnify Vishay for any damages arising or resulting from such use or sale. Please contact authorized Vishay personnel to obtain written terms and conditions regarding products designed for such applications.

Product names and markings noted herein may be trademarks of their respective owners.